

Major Ratings and Characteristics

| Characteristics | 31DQ.. | Units |
|----------------------------------|------------|------------|
| $I_{F(AV)}$ Rectangular waveform | 3.3 | A |
| V_{RRM} | 90/100 | V |
| I_{FSM} @ $t_p = 5 \mu s$ sine | 210 | A |
| V_F @3Apk, $T_J = 25^\circ C$ | 0.85 | V |
| T_J | -40 to 150 | $^\circ C$ |

Description/ Features

The 31DQ.. axial leaded Schottky rectifier has been optimized for very low forward voltage drop, with moderate leakage. Typical applications are in switching power supplies, converters, free-wheeling diodes, and reverse battery protection.

- Low profile, axial leaded outline
- High purity, high temperature epoxy encapsulation for enhanced mechanical strength and moisture resistance
- Very low forward voltage drop
- High frequency operation
- Guard ring for enhanced ruggedness and long term reliability

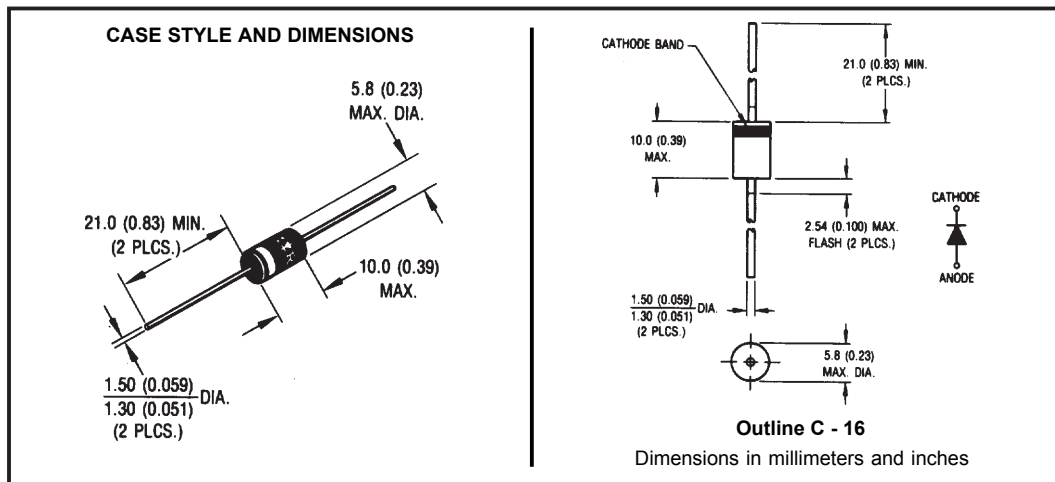

Voltage Ratings

| Part number | 31DQ09 | 31DQ10 |
|---|--------|--------|
| V_R Max. DC Reverse Voltage (V) | 90 | 100 |
| V_{RWM} Max. Working Peak Reverse Voltage (V) | | |

Absolute Maximum Ratings

| Parameters | 31DQ.. | Units | Conditions |
|---|--------|-------|--|
| $I_{F(AV)}$ Max. Average Forward Current * See Fig. 4 | 3.3 | A | 50% duty cycle @ $T_C = 53.4^\circ\text{C}$, rectangular wave form |
| I_{FSM} Max. Peak One Cycle Non-Repetitive Surge Current * See Fig. 6 | 210 | A | Following any rated load condition and with rated V_{RRM} applied |
| | 34 | | |
| E_{AS} Non-Repetitive Avalanche Energy | 3.0 | mJ | $T_J = 25^\circ\text{C}$, $I_{AS} = 1.0$ Amps, $L = 6$ mH |
| I_{AR} Repetitive Avalanche Current | 0.5 | A | Current decaying linearly to zero in 1 μsec Frequency limited by T_J max. $V_A = 1.5 \times V_R$ typical |

Electrical Specifications

| Parameters | 31DQ.. | Units | Conditions |
|---|--------|------------------|---|
| V_{FM} Max. Forward Voltage Drop * See Fig. 1 (1) | 0.85 | V | @ 3A $T_J = 25^\circ\text{C}$ |
| | 0.97 | V | @ 6A |
| | 0.69 | V | @ 3A $T_J = 125^\circ\text{C}$ |
| | 0.80 | V | @ 6A |
| I_{RM} Max. Reverse Leakage Current * See Fig. 2 (1) | 1 | mA | $T_J = 25^\circ\text{C}$ |
| | 3 | mA | $T_J = 125^\circ\text{C}$ $V_R = \text{rated } V_R$ |
| C_T Typical Junction Capacitance | 110 | pF | $V_R = 5V_{DC}$ (test signal range 100Khz to 1Mhz) 25°C |
| L_S Typical Series Inductance | 9.0 | nH | Measured lead to lead 5mm from package body |
| dv/dt Max. Voltage Rate of Change | 10000 | V/ μs | (Rated V_R) |

(1) Pulse Width < 300 μs , Duty Cycle <2%

Thermal-Mechanical Specifications

| Parameters | 31DQ.. | Units | Conditions |
|--|-------------|---------------------------|--------------------------------------|
| T_J Max. Junction Temperature Range | -40 to 150 | $^\circ\text{C}$ | |
| T_{stg} Max. Storage Temperature Range | -40 to 150 | $^\circ\text{C}$ | |
| R_{thJA} Max. Thermal Resistance Junction to Ambient | 80 | $^\circ\text{C}/\text{W}$ | DC operation Without cooling fins |
| R_{thJL} Typical Thermal Resistance Junction to Lead | 34 | $^\circ\text{C}/\text{W}$ | DC operation |
| wt Approximate Weight | 1.2 (0.042) | g (oz.) | |
| Case Style | C - 16 | | |

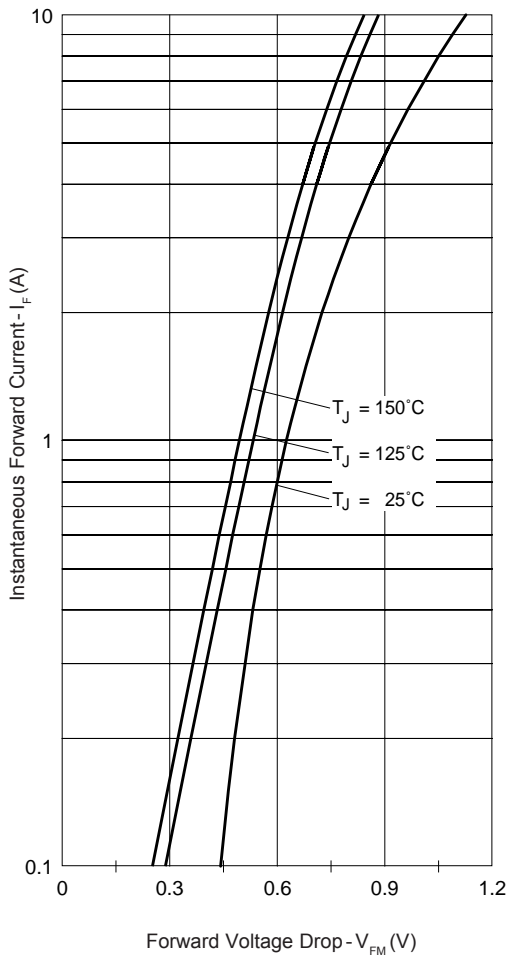

Fig. 1 - Max. Forward Voltage Drop Characteristics

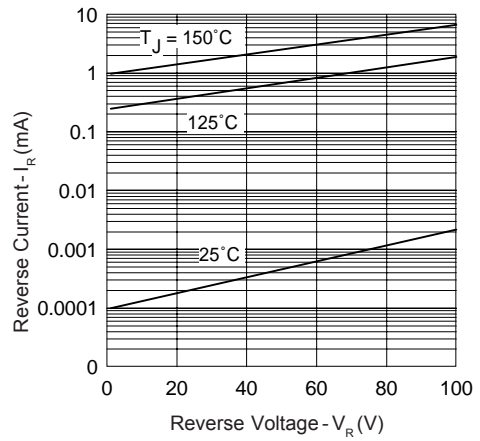

Fig. 2 - Typical Values Of Reverse Current Vs. Reverse Voltage

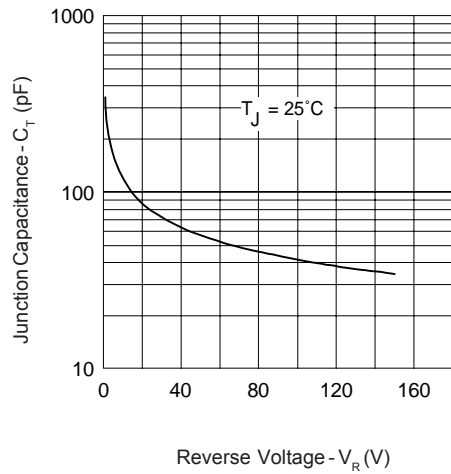

Fig. 3 - Typical Junction Capacitance Vs. Reverse Voltage

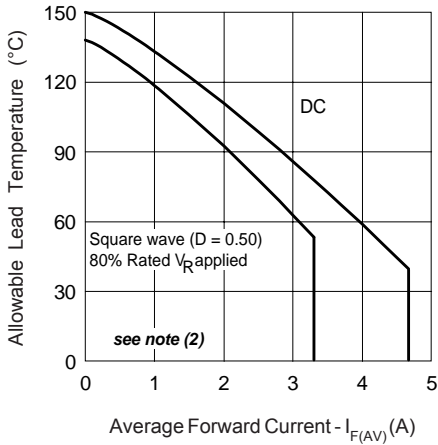

Fig. 4 - Max. Allowable Lead Temperature Vs. Average Forward Current

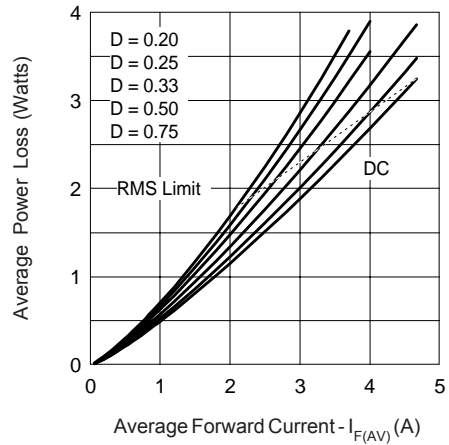

Fig. 5 - Forward Power Loss Characteristics

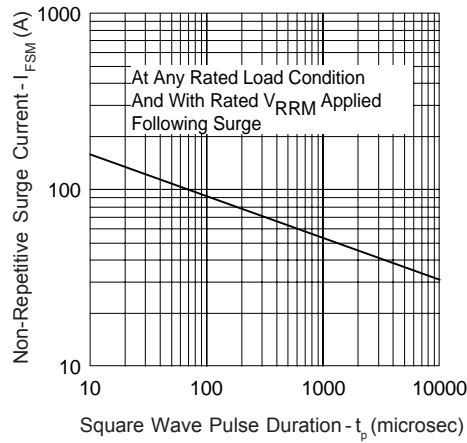

Fig. 6 - Max. Non-Repetitive Surge Current

(2) Formula used: $T_C = T_J - (Pd + Pd_{REV}) \times R_{thJC}$;
 $Pd = \text{Forward Power Loss} = I_{F(AV)} \times V_{FM} @ (I_{F(AV)} / D)$ (see Fig. 6);
 $Pd_{REV} = \text{Inverse Power Loss} = V_{R1} \times I_R (1 - D)$; $I_R @ V_{R1} = 80\% \text{ rated } V_R$

Ordering Information Table

| Device Code | | | | | | | | | | | |
|-------------|--|----|----|----|----|----|---|---|---|---|---|
| | <table border="1" style="margin: auto;"> <tr> <td style="padding: 5px;">31</td> <td style="padding: 5px;">D</td> <td style="padding: 5px;">Q</td> <td style="padding: 5px;">10</td> <td style="padding: 5px;">TR</td> </tr> <tr> <td style="text-align: center;">①</td> <td style="text-align: center;">②</td> <td style="text-align: center;">③</td> <td style="text-align: center;">④</td> <td style="text-align: center;">⑤</td> </tr> </table> | 31 | D | Q | 10 | TR | ① | ② | ③ | ④ | ⑤ |
| 31 | D | Q | 10 | TR | | | | | | | |
| ① | ② | ③ | ④ | ⑤ | | | | | | | |
| 1 | - 31 = 3.3A (Axial and small packages - Current is x10) | | | | | | | | | | |
| 2 | - D = DO-41 package | | | | | | | | | | |
| 3 | - Q = Schottky Q.. Series | | | | | | | | | | |
| 4 | - 10 = Voltage Ratings | | | | | | | | | | |
| 5 | - TR= Tape & Reel package (1200 pcs) | | | | | | | | | | |
| | - = Box package (500 pcs) | | | | | | | | | | |

10 = 100V
 09 = 90V

```

31DQ10
*****
* SPICE Model Diode *
*****
.SUBCKT 31DQ10 ANO CAT
D1 ANO 1 CAT
*Define diode model
.MODEL DMOD D(Is=56.46E-06 N=2.202 Rs=28.27E-03 Ikf=0.5957 Xti=2 Eg=1.11
+ Cjo=199.3E-12 M=0.4572 Vj=1.873 Fc=0.5 Isr=165.6E-24 Nr=4.955
+ Bv=119.9 Ibv=215.5E-06 Tt=21.64E-09)
*****
.ENDS 31DQ10
  
```

Data and specifications subject to change without notice.
 This product has been designed and qualified for Industrial Level.
 Qualification Standards can be found on IR's Web site.